

KICKER[®]



SOLOX

SUBWOOFER

Living Loud

OWNER'S MANUAL

S1B-X



SoloX Subwoofer Owner's Manual

Model: **S18X1/S18X2**

Attention:

Please take a moment and record the information asked for below in the provided area. It is also a good idea to attach the original sales receipt or a copy of it to this page for future reference

If for any reason you require service on this subwoofer during the warranty period, you will need to provide this information and a copy of the receipt to KICKER to validate your warranty. Please read the special SoloX warranty page!

ALWAYS KEEP YOUR RECEIPT!

Congratulations!

You have just purchased one of the most advanced subwoofers in the history of car audio. Your KICKER SoloX is the latest in KICKER's trend-setting Solo-Baric line, designed and engineered to deliver the ultimate in low bass performance and unmatched durability. Thanks for buying KICKER. Enjoy!

Dealer Where Purchased: _____

Purchase Date: _____

FEATURES

Titanium Deposit Impregnated Cone An Ultra High Performance look that is more rigid for less cone flex and less distortion.

Advanced Cone Technology The outer edge of the cone has been rolled to increase cone rigidity to decrease cone flex under high excursion.

SPAIR (Simple Pull Apart Insertable Replacement) A stamped steel removable cone assembly. (Patent Pending)

Uniplate V.2 with Vented Hyper-Extended Pole
(Patent Pending)

1. Utilizes "X" Vent technology to insure proper dissipation of heat away from the voice coil during operation.
2. Provides enhanced heat transfer for cool operation and maximum power handling.
3. Increases the linear magnetic fields around the voice coil gap for superior cone motion control.
4. Releases pressure under ISD for freer cone motion and enhanced low bass.

SLAM (SPAIR Lockdown Attachment Mechanism) The aluminum frame attached to the SPAIR which properly secures the removable speaker assembly (SPAIR) to the BAM (Basket And Motor assembly).

SPLAT (Speaker Precise Location Alignment Tool) Locates and anchors the BAM to the baffle of your enclosure.

ARCTIC Cap (Aluminum Rapid Cooling Thermal Induction Centering Cap) Mounted on top of the extended pole-piece it is responsible for insuring the voice coil on the SPAIR is properly centered when inserted into the BAM, adds more mass for increased thermal transfer from the voice coil to the pole piece and channels air into the "X" Vent for increased cooling.

S4 Quad Spider Array 4 Poly nomex spiders keeps the voice coil properly centered under high excursion.

Triple Stack Custom Tooled Magnets With a BAM this big, a double just wouldn't fill your appetite.

ISD (Inverted Structural Dome™) Further increases cone's resistance to flex under pressure.

Stitched Surround Prevents cone/surround separation at high excursions.

Dual Ultra-Length Voice Coils For high excursion and flexible wiring options.

Oversized 3.5" Voice Coil With bottom rolled out for increased retention capabilities.

Strain Relief Boots for Tinsel Lead Wires Large heavy gauge tinsel lead wire with strain relief boots.

B3-Link 3-Way Connection System which allows you to use Binding post, terminal Block, or Barrier strip for connecting the speaker wires.

The SoloX woofers are available with dual 2 Ohm or dual 1 Ohm voice coils. Both coils should always be hooked up.

The dual 2 Ohm woofer will give you a 1 Ohm or a 4 Ohm load depending on if the coils are wired in parallel or in series. The dual 1 Ohm woofer will give a .5 Ohm or 2 Ohm load depending on how they are wired.

The terminals with red and black wings are for one voice coil. The terminals with the silver colored wings are for the second voice coil.

Due to the nature of this subwoofer care must be taken when connecting the wires to the proper terminals!

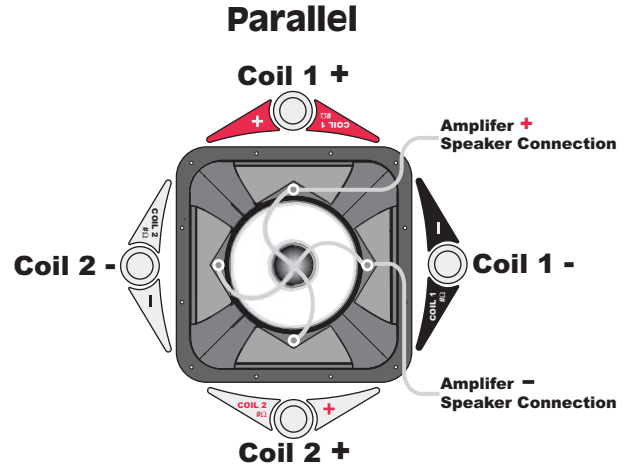
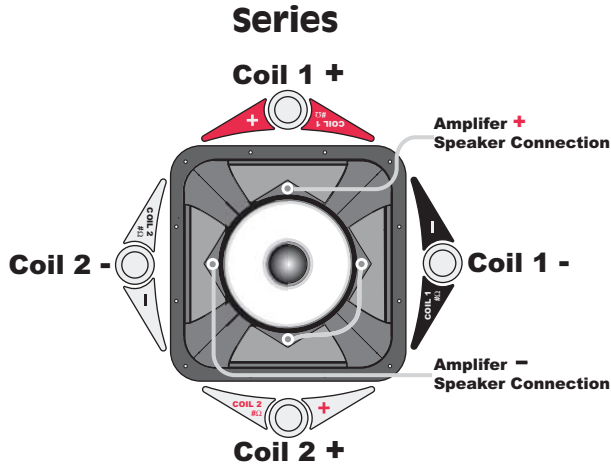

ENCLOSURES

The SoloX is one of the most advanced subwoofers on the market, therefore, care must be taken when designing an enclosure. We will provide you with enough information for you to properly construct an enclosure. If you feel you are not capable of building it yourself, we highly recommend letting one of our Authorized Dealers build it for you. It will save you a lot of heartaches and headaches. The SoloX subwoofer is capable of handling unheard of power. A simple enclosure will not be enough. The enclosure will need to be made of a minimum of 1" MDF and properly braced. You may use 4" x 4" (10.16cm x 10.16cm) triangular braces between each of the larger unsupported panels or a center brace (as seen on the next page). We also recommend using a good grade wood glue and silicone rubber to insure an airtight seal.

The wood support inside your SoloX shipping carton can be used as a template for cutting the speaker mounting hole in the enclosure. Since the wood cut out is the same size as the basket of the SoloX, when you make the cut along the line drawn through the template, make sure to cut right on the line to get the correct opening size.

All the cubic feet numbers given in the following pages include the displacement of the woofer. *For the ported boxes the displacement of the port must be added to the final design.* It will be impractical to use round ports for these designs. The rectangular port information given will yield the best results. Keep in mind the pressure inside of a ported enclosure exceeds that of a sealed enclosure

Note: If you prefer an ultra-smooth bass response, you should loosely fill your SoloX Enclosure with polyfil. Ported designs will require covering the entrance to the port (inside the box) with hardware cloth, chicken wire, or expanded metal to prevent the polyfil from being blown out through the port. Use of polyfil will slightly decrease efficiency, but will deepen and extend low bass response.

Do not install a ported box with the port against a solid surface. The port opening must remain unobstructed. Use the smallest dimension of the rectangular port as the minimum amount of space required between the port and any surface to insure unrestricted airflow.

For more advice on box building, see the Choosing and Building Enclosures page in the Tech Tips & FAQs section of the Support area on the Kicker website, www.kicker.com Or call Technical Services at 1-405-624-8583.

A note on power handling capability

SoloX subwoofers will handle massive amounts of power in any of the recommended enclosures. The power ratings given are assuming that both voice coils are used. You should never hook up a dual voice coil woofer using only one coil.

SoloX Series Sealed Enclosure Applications

The SoloX is designed for Vented enclosure/ High SPL applications and that is where maximum output and power handling will be achieved. If you are willing to give up maximum SPL and power handling for more low bass output, then you can utilize our sealed enclosure recommendations. These sealed enclosure recommendations will give the smoothest response with the most energy at really low frequencies, around 20 to 30 Hz.

The recommended Tuner sealed box will deliver massive amounts of high impact bass and can be driven with punishing levels of amplifier power.

One of the benefits of the SoloX series high performance suspension system is that they can operate in larger sealed enclosures for ultra low bass performance (SUV applications) while still maintaining excellent control and power handling.

SoloX series woofers also perform well in any sealed enclosure between the Tuner and SUV sizes. These systems will exhibit some benefits of both (high impact and low extension) generally sounding more like the box to which they are most closely sized.

These enclosure volume recommendations are for the airspace inside the enclosure and include the displacement of the woofer. Do not make the airspace any greater than recommended.

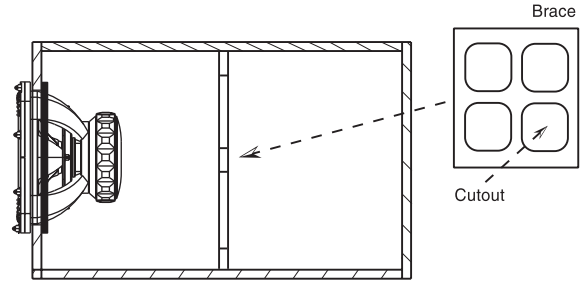

S18X **Recommended Enclosures**

Model

Tuner:

6 cu.ft., Fb = 51.3Hz
F3 = 24.6Hz, Pmax = 2800W

SUV:

12 cu.ft., Fb = 48.8Hz
F3 = 22.2Hz, Pmax = 2400W

For more enclosure choices check out our website www.kicker.com or call our Technical service line at 1-405-624-8583.

SoloX Series Vented Enclosure Applications

The Kicker SoloX is truly awesome in a vented enclosure as this is what it was designed for. Throw out every experience you have ever had with a vented speaker and prepare to be blown away! Our engineers have designed several boxes that will truly irritate everyone within a 3 mile radius.

Because a woofer of this magnitude has never been produced, even we do not know the total capabilities of the SoloX. The following chart shows three recommended vented enclosures for the SoloX: Tuner, SUV, and SPL. Keep in mind, these enclosure volume recommendations are for the airspace inside the enclosure and include the displacement of the woofer. Do not make the airspace any greater than recommended. These enclosures are just scratching the abilities of this woofer to blow away all other woofers on the market. So keep your eye on the website for the newest sick enclosures!

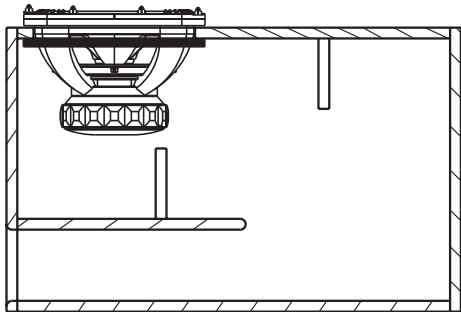

S18X Recommended Enclosures

Tuner :	5 cu.ft. Port: 60sq.in. x 14.5" Fb = 35Hz, Pmax = 5000W (with 25hZ subsonic filter)
SUV:	10 cu.ft. Port: 150 sq.in. x 21" Fb = 35Hz, Pmax = 4500W (with 25hZ subsonic filter)
SPL:	10 cu.ft. Port: 300sq.in. x 9" Fb = 56Hz, Pmax = 10000 (Above tuning freq. only) See below!

This enclosure is intended for SPL ONLY! It is designed to be used with test tones above 56Hz! Playing music with frequencies below 56Hz will result in very, very bad things happening!!

For more advice on box building, see the Choosing and Building Enclosures page in the Tech Tips & FAQs section of the Support area on the Kicker website, www.kicker.com Or call Technical Services at 1-405-624-8583.

ATTENTION!

The hardware we include will work with baffles up to 1.5" thick. For thicker baffles you will need to use longer 1/4" x 20 hardware.

MOUNTING

Now that you have opened the box and read "The Adventures of Sam Stikman" and decided on which enclosure design to use, you may now remove the SoloX from it's box. Please follow the instructions lined out here to insure proper installation.

1. With assistance from a friend remove the SoloX from the cardboard facilitation chamber.

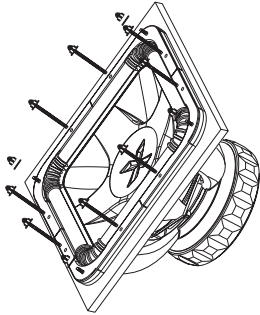

2. Once out of the carton remove the (4) four acorn head nuts and (8) eight bolts securing the SPAIR to the BAM and wood baffle assembly. Place SPAIR in safe clean location!

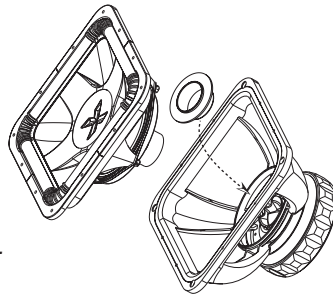

ATTENTION!
3. Install the Gap Cap into the BAM around the pole-piece to protect the motor assembly from debris while you are installing the woofer. If any metal shavings were to fall into the gap, they would be impossible to remove! Please use the Gap Cap!

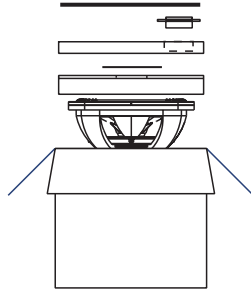

4. With the Gap Cap now installed remove the (4) double end threaded studs that lock the BAM to the wood baffle assembly.

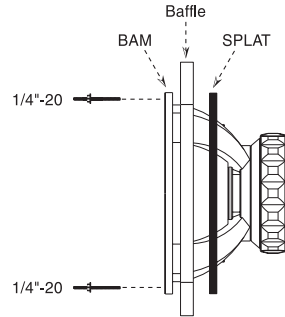

The SPLAT and wood baffle will now come free from the BAM. The baffle will now become your mounting template.

5. Place the wood template on your enclosure baffle to mark the holes for mounting.

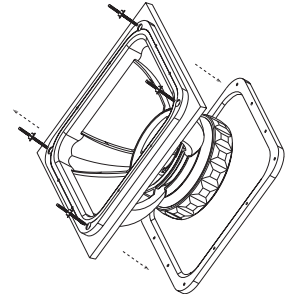
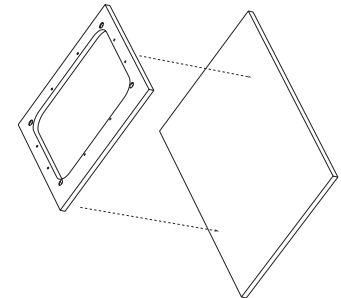

6. Once the holes are marked remove template. Using a jigsaw cutout the woofer hole and use a 3/8" drillbit for the mounting holes

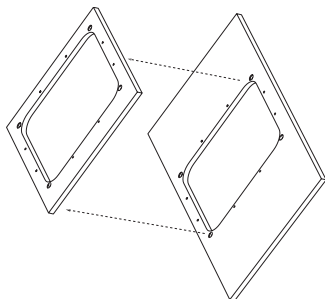
**WARNING!**

You will need assistance for the following steps!

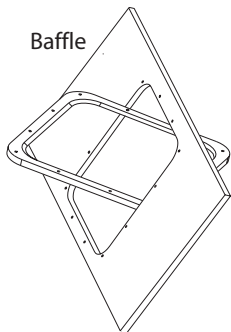

Baffle

7. Insert the SPLAT into the cutout and move into position.

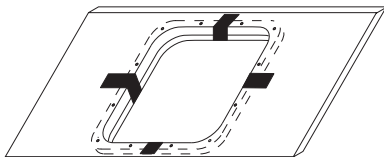

8. Use masking tape to temporarily hold the SPLAT in place while securing the BAM. This tape can be removed after the corner hardware has been started.

9. With your assistant, insert the BAM and start the corner hardware. Now is the time you remove the unidirectional bonding strip! (Tape) Tighten the double threaded studs to secure the baffle.

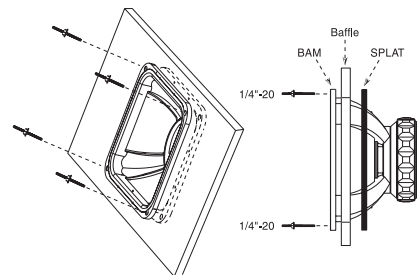

10. Pull the wires out through the BAM and connect to the B3 Link of your choice. *Make sure you are using proper polarity!*

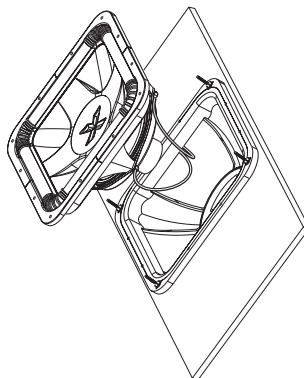

11. Remove the Gap Cap before inserting SPAIR.

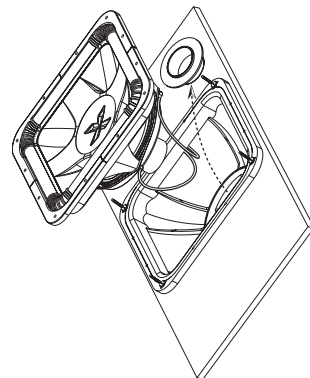

12. Insert the SPAIR back into the BAM. Be careful not to damage the voice coil. The double threaded studs and the ARCTIC Cap will help to center SPAIR as you lower it into the BAM. When properly aligned these assemblies slide together easily.

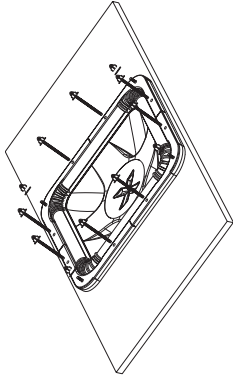
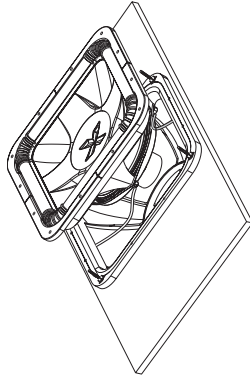

13. Using the 1/4"-20 acorn head nuts and eight bolts secure the SPAIR to the BAM. When tightening the nuts follow the pattern drawn below. This will insure a proper fit.

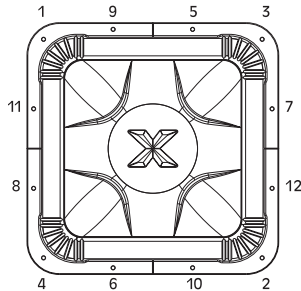

ATTENTION!

Follow the pattern, hand tighten each, then go back and tighten using the same pattern.

14. Pop open a cold beverage and admire your work!

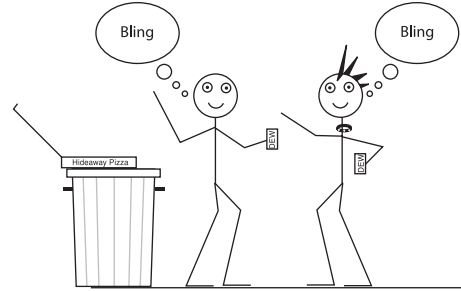

SPECIFICATIONS

Model:	S18X1	S18X2
Nominal Impedance (Impedance per coil)	1	2
SPL 1W/1M	90.27	89.7
Displacement, cc	3930	3930
Displacement, Culin	239.8	239.8
Mounting Depth	11-3/8	11-3/8
Revc	2.05	4.07
VC Inductance, mH	3.247	4.289
Sd, SqM	0.1426	0.1426
BL	31.45	40.36
Vas, Liters	185.64	177.61
Vas, CuFt	6.55	6.27
Mms, gms	859.8	836.5
Fs	21.4	22.18
Qms	8.838	7.83
Qes	0.240	0.291
Qts	0.233	0.281
Pmax, Peak watts	10000	10000
RMS watts	5000	5000
EXmax, mm (Excursion maximum)	24.48	24.48

SOLOX LIMITED WARRANTY

KICKER warrants this product to be free from defects in material and workmanship under normal use for a period of **THREE (3) MONTHS** from date of original purchase. When purchased from an Authorized KICKER Dealer this product is warranted for **ONE (1) YEAR** from date of purchase. If the product is labeled "B Stock" it is warranted for **THREE (3) MONTHS** from date of purchase. Should service be necessary under this warranty for any reason due to manufacturing defect or workmanship during the warranty period, KICKER will replace or repair (at its discretion) the defective merchandise with equivalent merchandise at no charge. Warranty replacements on "B Stock" merchandise may have cosmetic scratches and blemishes. Discontinued products may be replaced with more current equivalent products.

This warranty is valid only for the **original purchaser** and is not extended to owners of the product subsequent to the original purchaser. Any applicable implied warranties are limited in duration to a period of the express warranty as provided herein beginning with the date of the original purchase at retail, and no warranties, whether express or implied, shall apply to this product thereafter. Some states do not allow limitations on implied warranties, therefore these exclusions may not apply to you.

This warranty gives you specific legal rights; however you may have other rights that vary from state to state.

SHOULD YOU NEED SERVICE

Defective merchandise must be returned to your local Authorized Stillwater Designs (KICKER) Dealer for warranty. Assistance in locating an Authorized Dealer can be obtained by writing or calling Stillwater Designs (KICKER) direct. You can confirm that a dealer is authorized by asking to see a current authorized dealer window decal.

If it becomes necessary for you to return defective merchandise, call the KICKER Customer Service Department at (405)624-8510 for a Return Merchandise Authorization (RMA) number. Package all defective items in the original container or in a package that will prevent shipping damage, and return to

Stillwater Designs, 5021 North Perkins Road, Stillwater, OK 74075

The RMA number must be clearly marked on the outside of the package. Return only defective components. Return of the entire cabinets, system packs, pairs, etc. increases your return freight charges. Non-defective items received will be returned freight collect. Include a dated proof-of-purchase stating the Customer name, Dealer name, product purchased and date of purchase.

Warranty expiration on items without proof-of-purchase will be determined from the manufacturing date code. Freight must be prepaid; items received freight collect will be refused. Failure to follow these steps may void your warranty.

Any questions can be directed to the KICKER Customer Service Department at (405)624-8510

This warranty is valid only if the product is used for the purpose for which it was designed.

CAUTION: BURNT VOICE COILS ARE NOT COVERED UNDER WARRANTY

In addition, the warranty does not cover:

- * Damage due to improper installation.
- * Subsequent damage to other components.
- * Damage caused by exposure to moisture, excessive heat, chemical cleaners, and/or UV radiation.
- * Damage through negligence, misuse, accident or abuse.
- * Any cost or expense related to the removal or reinstallation of the product.
- * Speakers damaged due to amplifier clipping or distortion.
- * Speaker with any foreign caulk used for gasket material.
- * Items previously repaired or modified by any unauthorized repair facility.
- * Return shipping on non-defective items.
- * Products with tampered or missing barcode labels.
- * Products returned without a Return Merchandise Authorization (RMA) number.
- * Freight damage.
- * The cost of shipping the product to Kicker.
- * Service performed by anyone other than Kicker.

HOW LONG WILL IT TAKE

Stillwater Designs (KICKER) maintains a goal of 24-hour service for all returns. Delays may be incurred if lack of replacement inventory or parts is encountered.

INTERNATIONAL WARRANTY

Contact your International Stillwater Designs (KICKER) dealer or distributor concerning specific procedures for your country's warranty policies.



P.O. Box 459 • Stillwater, Oklahoma 74076 • U.S.A. • 405 624-8510

STILLWATER
Designs®

WARNING:

KICKER drivers are capable of producing sound levels that can permanently damage your hearing! Turning up a system to a level that has audible distortion is more damaging to your ears than listening to an undistorted system at the same volume level. The threshold of pain is always an indicator that the sound level is too loud and may permanently damage your hearing.

Please use common sense when controlling volume!

SOLOX LIMITED WARRANTY

Ok, you have read all the fine print on the previous page describing the warranty on a Solo X Subwoofer, (enough there to make even Judge Judy happy) but what does it all mean? Well, let's just lay it all out in as simple of terms as possible.

The Solo X is a high performance machine that is built to take gobs of power, play extremely loud and create enough low bass to rattle the fillings out of your friend's teeth who lives in the next county. It is built using the finest materials and highest degree of workmanship we have available. It is the NASCAR of subwoofers...designed to be driven hard into all four corners...and we are sure you will drive it just that way!

With all that being said...we know some of you will still be able to break this product...it is a plain and simple fact. When you build an extreme product to be used by extreme people these people can and will find the breaking point...just like Tony Stewart snapping a rod in a motor.

That is why we designed the Solo X to have a permanently mounted BAM (Basket And Motor) assembly with a replaceable soft parts assembly, the SPAIR (Simple Pull Apart Insertable Replacement), so that when you find the breaking point (and if you can still hear or feel) you can re-build it on the spot. If you read the big poster that came with your woofer (you did...right?) you know Sam & Sid told you this thing weighs more than a Mini Cooper (well...really it weighs in at near 100 pounds). The BAM which is about 90% of the weight in a Solo X stays mounted in your enclosure AND in your car; you simply exchange the much lighter SPAIR. This saves you all the fun of wrestling with the entire Solo X and the ENORMOUS costs of shipping a 100 pound woofer to Stillwater, Oklahoma.

The SPAIR and all the parts contained within it are not warranted for:

- Burnt, Shucked, Bent, Unraveled or Open Voice Coils.
- Torn, Ripped or Punctured Surrounds.
- Torn, Ripped or Punctured Cones.
- Torn, Ripped or Punctured Spiders.
- Burnt or Frayed Tinsel Leads.

We also do not warranty the SPAIR for:

- Wear and Tear under normal use.
- Product damaged due to abuse.
- Damage to Vehicle and/or other components of the sound system.
- Scattered, Smothered, Covered and Chunked units.

The SPAIR and BAM are not covered under warranty for any damage due to shipping or improper packaging.

So what will KICKER cover under warranty?

- Poor or misaligned glue joints.
- Poor or misaligned parts.
- Material, Machining or Assembly flaws with the BAM.

So in a nut-shell if and when you break it (which takes A LOT) you simply return the soft parts assembly (the SPAIR) to your local dealer and purchase another SPAIR. If there is a problem with the SPAIR and you feel it should be covered under warranty, you will need to obtain an RMA from KICKER before sending it back. If only the SPAIR is defective, there is no need to send the entire structure back to KICKER. Refer to **SHOULD YOU NEED SERVICE** on the previous page for the details.

Special Note: OK that all sounds pretty black and white but we are KICKER and we know stuff happens. If your Solo X stops working and after pulling the SPAIR you find a failure other than that mentioned above that you feel is a manufacturing defect or poor workmanship you may call Stillwater Designs (KICKER) for a RMA (Return Merchandise Authorization). You will then have to wrestle the big unit, meaning the Solo X Subwoofer, (BAM and SPAIR both) and pack them in the original shipping container that you got at the time of purchase. You **MUST** use the original packing to protect the unit during shipping!!! You will be responsible for the freight charges.

After receiving your Solo X and examining it, one of three things will happen.

- If a problem is found that is indeed covered under warranty, we will repair the unit and return it to you at no additional charge.
- If no problem is found we will return the unit to you and you will be responsible for the freight charge.
- If a problem is found that is not covered under the warranty as described in the warranty statements, you will be charged for the cost of the repair and freight charge to return the unit to you.

